

Data sheet

Adjustable temperature switch / controller with actual value display

Type: ETSM-1...

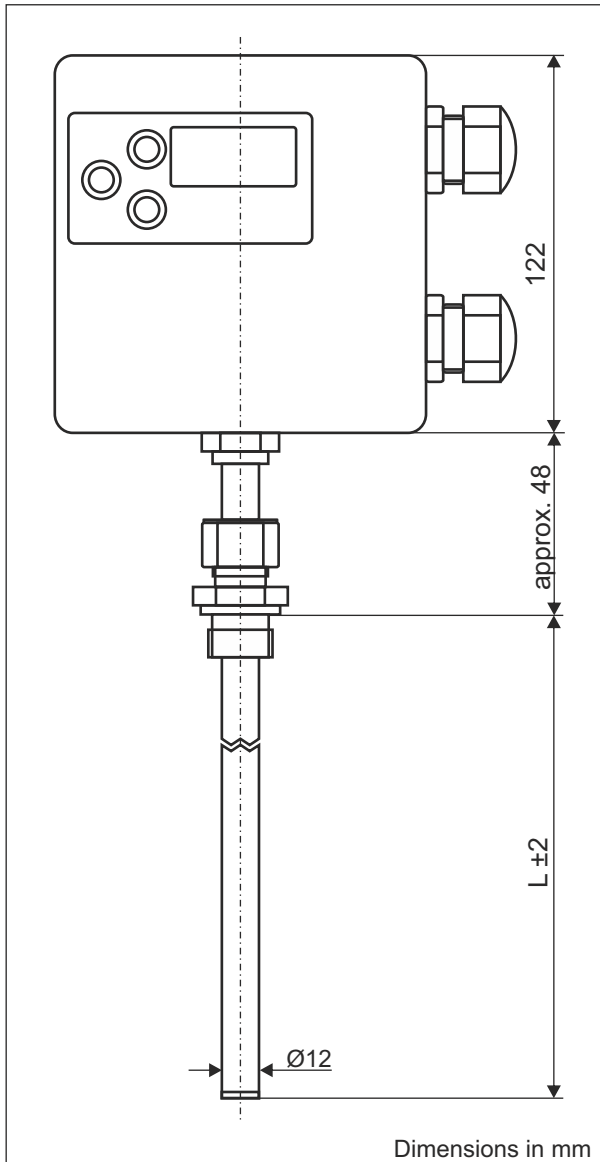

Features

- Adjustable temperature switch up to a max. of 6 steps
- Temperature sensor in tube, mounted on the housing or externally via cable connection
- 3-digit display
- 6 Temperature limit value LEDs
- Menu-driven parameter adjustment
- Optionally with diverse temperature sensors
- hysteresis is freely selectable

Fields of application

- Temperature control
- Monitoring of cooling and heating circuits
- Temperature overload protection for systems
- Process control

Order key

Type ETSM-1

Number of temperature steps, max.6

Sensor tube length L in mm

Design see page 2:

- 01 = alu housing with 2x M20x1,5 cable gland, mounting via 1/2" thread
- 02 = alu housing with 2x M20x1,5 cable gland with oval flange mounting
- 03 = alu housing with separate sensor, 3x M16x1,5 cable gland, M12 plug-type connector for the external sensor

Example: **ETSM-1. 4. 350. 01**

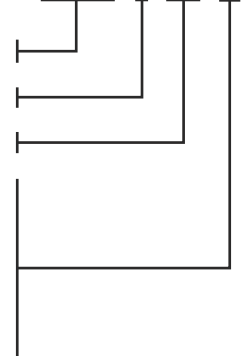

Terminal diagram

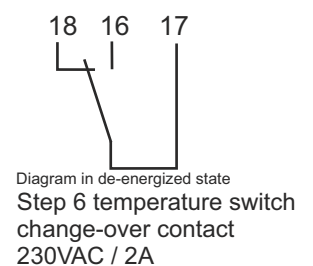
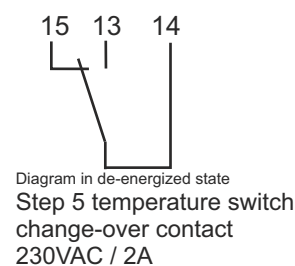
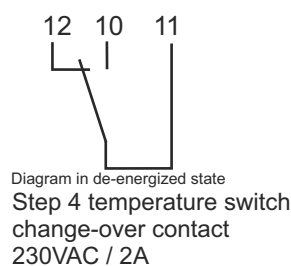
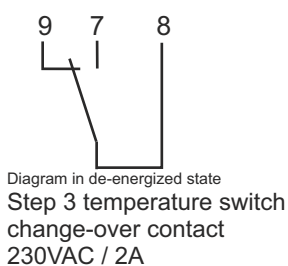
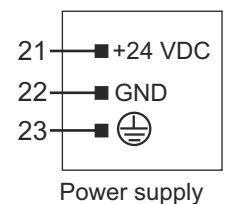
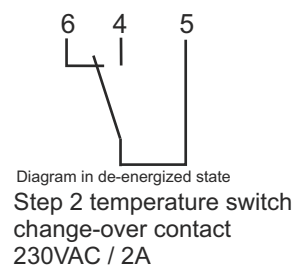
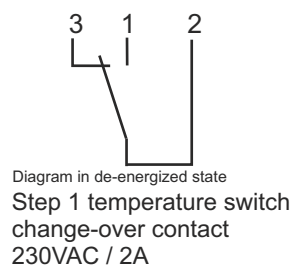

Data sheet

Adjustable temperature switch / controller with actual value display

Type: ETSM-1...

Technical data

Housing:	alu housing 122 x 120 x 65mm (wxixd),
Connection:	cable entry see designs, terminal connection: conductor cross section flexible 1,0mm ² to 1,5mm ²
Mounting:	screwed cable gland or flange mounting depending on design
Mounting position:	360° rotatable
Seal:	material NBR
Sensor tube:	ø12mm, length L in mm acc. to customer specification, material brass
Display:	red 3-digit display, height 13mm
Switching points:	max. 6x change-over relays
Setting range:	-20°C to 120°C hysteresis is freely selectable
Measuring range :	measuring range -55°C to 125°C Measuring accuracy: ±0,5°C from -20 °C to 125 °C resolution 0,5°C, display resolution 1,0°C
Switching capacity:	230VAC / 2A
Supply voltage:	24VDC reverse polarity protected, other supply voltage on request
Operating current:	<120mA
Pressure:	max. 1 bar, higher pressure on request
Operating temperature:	-20°C to 100°C in medium, -20 to 70°C above mounting
Protection rating:	IP 65
Certificate:	in accordance with CE

Designs

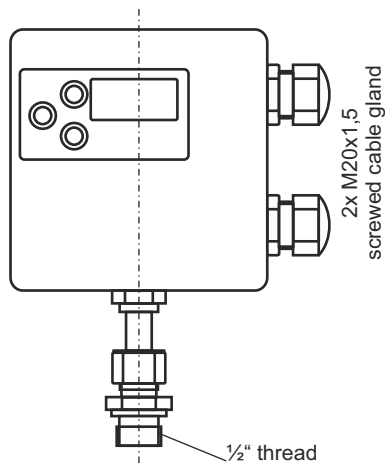

Design 01

Mounting via 1/2" thread
screwed cable gland 2x M20x1.5
sensor tube ø12mm, material brass
immersion depth of the tube will be adjusted
via the thread

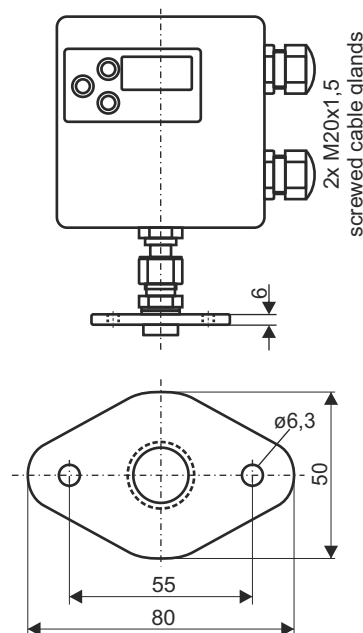

Design 02

Oval-flange mounting
screwed cable gland 2x M20x1.5
sensor tube ø12mm, material brass
immersion depth of the tube will be adjusted
via the thread

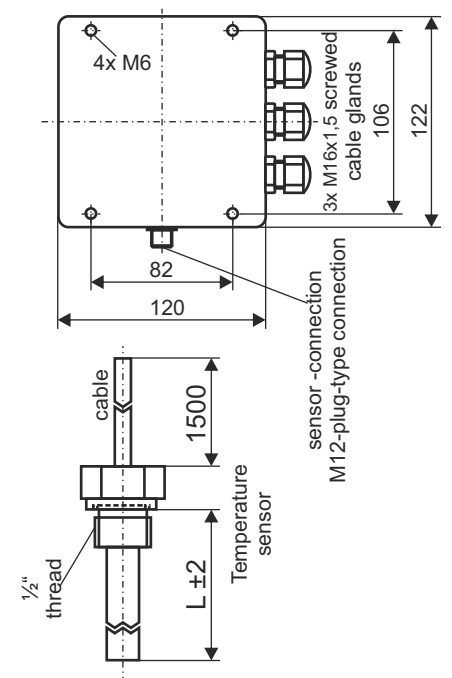

Design 03

Mounting over alu housing
with separate sensor
screwed cable glands 3x M16x1.5
sensor tube ø12mm, material brass

Dimensions in mm